



STORAX[®]

ONLEVEL

**GLASBALUSTRADES
EN VALBEVEILIGINGEN**

TL-3031

3.0 kN Zijmontage

The Power of Improvement.

De echte krachtpatser onder de glasbalustrades. Het is het profiel dat het meest wordt gebruikt bij drukbezochte projecten. Geen profiel is sneller te monteren. Geen profiel kost zo weinig inspanning. Zelfs grote belastingen zijn geen probleem.

Zoals alle profielen van ONLEVEL laat zich de TL-3031 zowel in binnen- als ook in buitentoepassingen gebruiken. Het is bestand tegen een lineaire belasting van meer dan 3.0 kN en is geschikt voor glasdiktes tussen 21,52 mm en 31,52 mm.

Belangrijke kenmerken

- | Slanke, fraaie vormgeving en onderhoudsarm
- | ONLEVEL FLEXFIT glasmontagesysteem
- | Verlengstiftkanalen
- | Afwateringsopeningen
- | Top cover (als optie)
- | Deel-afdekkap (als optie)
- | In hoogte verstelbaar
- | Voor glasdiktes 21,52 - 31,52 mm

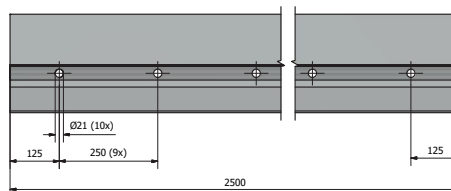
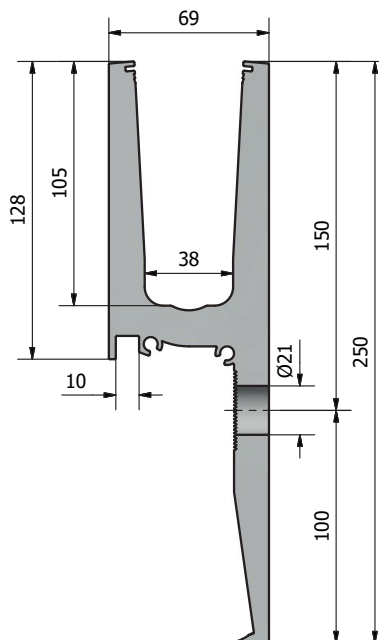
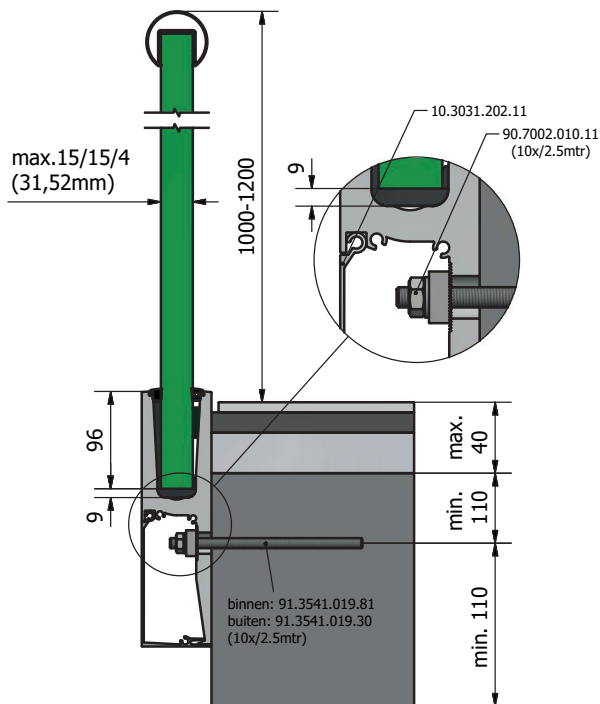

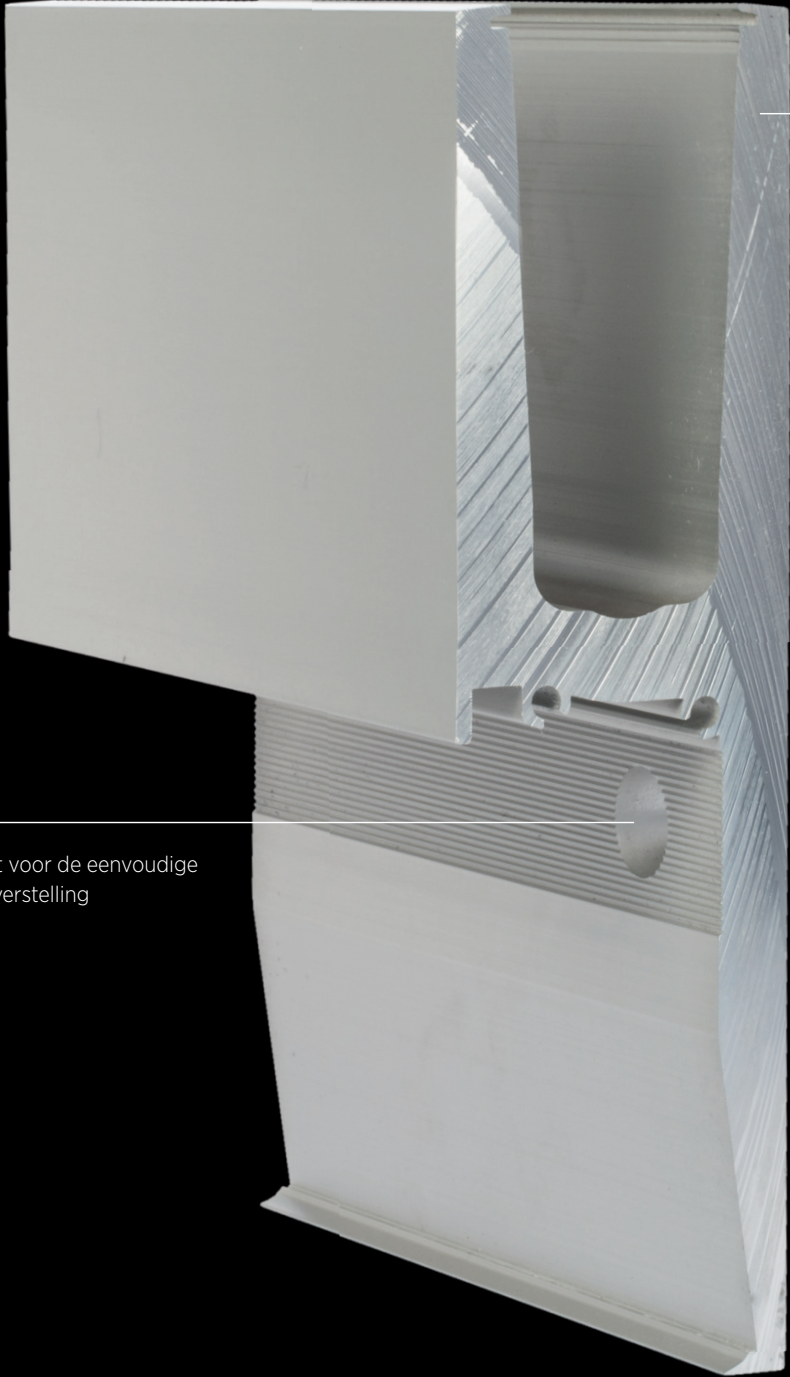

Voor drukbezochte
bouwprojecten

Langgat voor de eenvoudige
hoogteverstelling



Zijmontage

TL-3031 | 3.0KN ZIJMONTAGE

Glasprofiel



- | Hoogte 250 mm
- | Breedte 69 mm
- | VE: 1 stuks

Model 3031	Aluminium naturel
Lengte	Art. nr.
2500	10.3031.002.11

Binnenhoek 90°



- | Zijlengte binnen 131 mm
- | Zijlengte buiten 200 mm
- | VE: 1 stuks

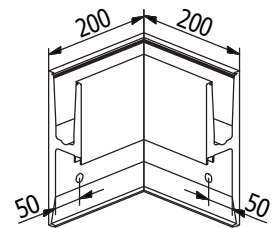

Model 3031	Aluminium naturel
	Art. nr.
	10.3031.300.11

Buitenhoek 90°



- | Zijlengte binnen 131 mm
- | Zijlengte buiten 200 mm
- | VE: 1 stuks

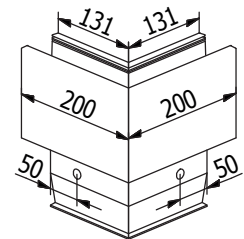

Model 3031	Aluminium naturel
	Art. nr.
	10.3031.350.11

Eindkap met afdeklíst links



- | links te gebruiken
- | VE: 1 stuks

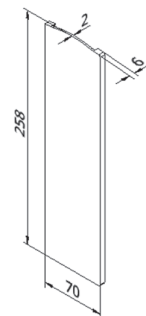

Model 3031	Aluminium naturel
Toepassing	Art. nr.
links	10.3031.410.11

TL-3031 | 3.0KN ZIJMONTAGE

Eindkap met afdeklíjst rechts



| rechts te gebruiken
| VE: 1 stuks

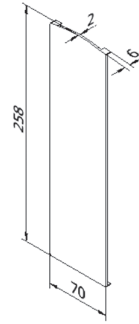

Model 3031	Aluminium naturel
Toepassing	Art. nr.
rechts	10.3031.460.11

Afdeklíjst



| VE: 1 stuks

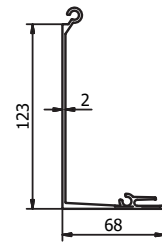

Model 3031	Aluminium naturel
Lengte	Art. nr.
2500	10.3031.202.11
5000	10.3031.205.11

Montageblok

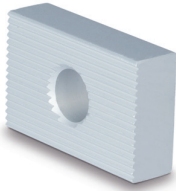

| Benodigd aantal per 2500 mm: 10 stuks
| VE: 8 stuks

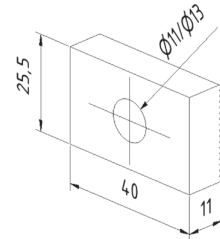

Model 7002	Aluminium naturel
Binnengat	Art. nr.
Ø 11 mm	90.7002.010.11
Ø 13 mm	90.7002.012.11

Verlengstift



| lengte 40 mm
| Diameter Ø 6 mm
| VE: 8 stuks

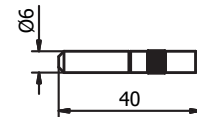

Model 7001	316 (binnen & buiten)
	Art. nr.
	90.7001.640.31

TL-3031 | 3.0KN ZIJMONTAGE

Fischer bevestigingsanker RG M10x190



- | Oppervlakte binnentoepassing: staal verzinkt (binnen)
- | Oppervlakte buitentoepassing: 316 (buiten)
- | Benodigd aantal per 2500 mm: 10 stuks
- | M10
- | Bijpassende mortel: 91.3000.010.00
- | Injectiemortel (91.3000.010.00) genoeg voor ± 22 ankers
- | VE: 10 stuks

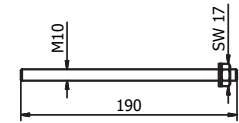

Model 3541	Staal verzinkt (binnen)	316 (buiten)
	Art. nr.	Art. nr.
	91.3541.019.81	91.3541.019.30

Montageset op staal



- | Oppervlakte binnentoepassing: staal verzinkt (binnen)
- | Oppervlakte buitentoepassing: 316 (buiten)
- | Benodigd aantal per 2500 mm: 10 stuks
- | M10 x 60 mm
- | VE: 10 stuks

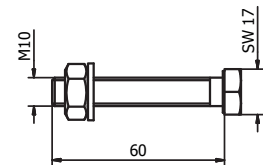

Model 3031	Staal verzinkt (binnen)	316 (buiten)
	Art. nr.	Art. nr.
	91.3031.060.81	91.3031.060.30

FLEXFIT 3.0 kN



- | Fijnafstelling van glasplaten
- | Voor glasdiktes 21,52 - 31,52 mm
- | Uitlijning van max. 34 mm ten opzichte van de loodlijn
- | Let op de juiste glasdikte!

Lengte		2500 mm	5000 mm	25 m
Glasdikte	Wig-kleur	Art. nr.	Art. nr.	Art. nr.
10/10/4 (21,52 mm)	blauw	90.0502.322.00	90.0505.322.00	90.0525.322.00
12/12/4 (25,52 mm)	rood	90.0502.326.00	90.0505.326.00	90.0525.326.00
15/15/4 (31,52 mm)	groen	90.0502.332.00	90.0505.332.00	90.0525.332.00