



**STORAX**<sup>®</sup>

**ONLEVEL**

**GLASBALUSTRADES  
EN VALBEVEILIGINGEN**

# TL-6021

1.0kN Zijmontage

## The Evolution goes on.

Het profiel TL-6021 is de intelligente verdere ontwikkeling van het profiel TL-6011. Het bijzondere hierbij is dat de bevestigingsafstanden werden vergroot en ze zelfs ook op een boutanker zonder verzonken kop gebruikt kunnen worden. Daardoor kan het product niet slechts aanzienlijk sneller en voordeliger gemonteerd worden, maar ook de statische eigenschappen zijn aanzienlijk verbeterd.

Het profiel TL-6021 is in buitentoepassingen bruikbaar. Het is bestand tegen een lineaire belasting van 1.0 kN en is geschikt gemaakt voor glasdiktes tussen 12 mm en 21,52 mm.

## Belangrijke kenmerken

- | Slanke, fraaie vormgeving en onderhoudsarm
- | ONLEVEL FLEXFIT glasmontagesysteem
- | Afwateringsopeningen
- | Top cover (als optie)
- | Top Cover van 3.0 kN gebruiken
- | Voor glasdiktes 12 - 21,52 mm
- | Bij toepassing in de persoonlijke leefomgeving 0,5 kN ligt de bevestigingsafstand op 40 cm



**STATISCHE  
BEREKENING**  
conform **NEN2608**

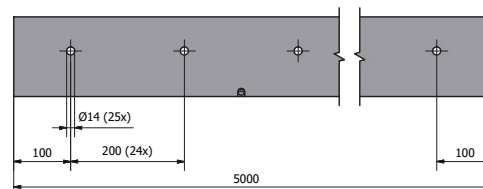
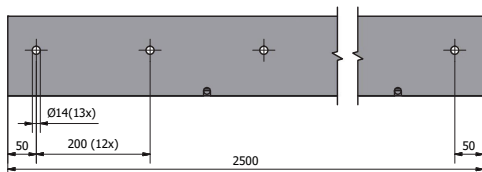
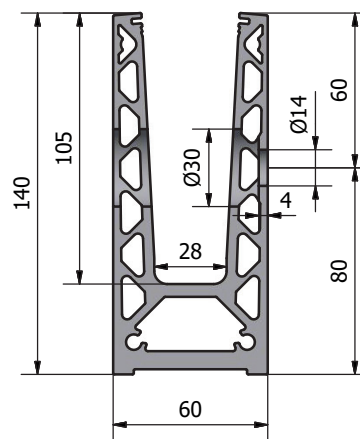
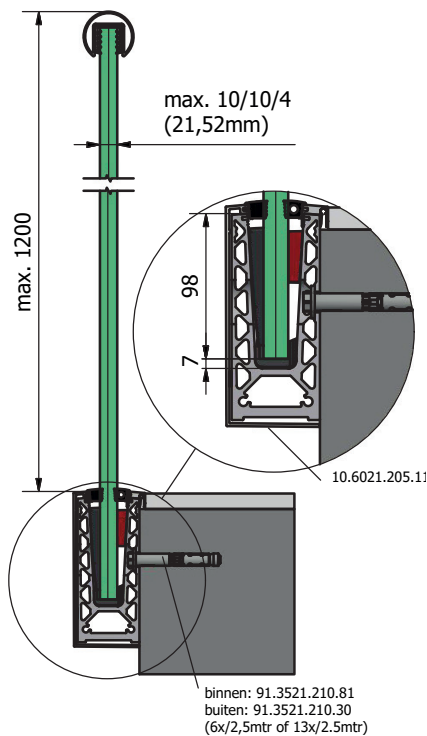



Verbeterde statische eigenschappen

Afhankelijk van de toepassing universeel te verankeren



Zijmontage

Geïntegreerde torsiebox om boorafstanden te vergroten

# TL-6021 | 1.0KN ZIJMONTAGE

## Glasprofiel



| Hoogte: 140 mm  
| Breedte: 60 mm  
| VE: 1 stuks

Model 6021	Raw	Aluminium naturel	In kleur
Lengte	Art. nr.	Art. nr.	Art. nr.
2500	-	10.6021.002.11	-
5000	10.6021.005.10	10.6021.005.11	10.6021.005.13/16/18

## Binnenhoek 90°



| Zijlengte binnen 140 mm  
| Zijlengte buiten 200 mm  
| VE: 1 stuks

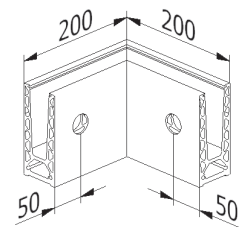

Model 6021	Onbehandeld	Aluminium naturel	In kleur
	Art. nr.	Art. nr.	Art. nr.
	10.6021.300.10	10.6021.300.11	10.6021.300.13/16/18

## Buitenhoek 90°



| Zijlengte binnen 140 mm  
| Zijlengte buiten 200 mm  
| VE: 1 stuks

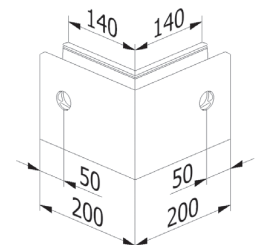

Model 6021	Onbehandeld	Aluminium naturel	In kleur
	Art. nr.	Art. nr.	Art. nr.
	10.6021.350.10	10.6021.350.11	10.6021.350.13/16/18

## Eindkap links



| links te gebruiken  
| VE: 1 stuks

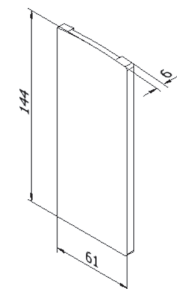

Model 6021	Onbehandeld	Aluminium naturel	In kleur
Toepassing	Art. nr.	Art. nr.	Art. nr.
links	10.6021.400.10	10.6021.400.11	10.6021.400.13/16/18

# TL-6021 | 1.0KN ZIJMONTAGE

## Eindkap links met afdeklíjst



| links te gebruiken  
| VE: 1 stuks

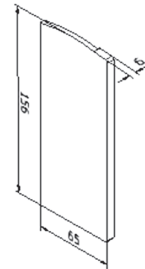

Model 6021	Onbehandeld	Aluminium naturel	In kleur
Toepassing	Art. nr.	Art. nr.	Art. nr.
links	10.6021.410.10	10.6021.410.11	10.6021.410.13/16/18

## Eindkap rechts



| rechts te gebruiken  
| VE: 1 stuks

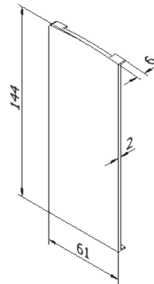

Model 6021	Onbehandeld	Aluminium naturel	In kleur
Toepassing	Art. nr.	Art. nr.	Art. nr.
rechts	10.6021.450.10	10.6021.450.11	10.6021.450.13/16/18

## Eindkap rechts met afdeklíjst



| rechts te gebruiken  
| VE: 1 stuks

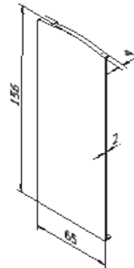

Model 6021	Onbehandeld	Aluminium naturel	In kleur
Toepassing	Art. nr.	Art. nr.	Art. nr.
rechts	10.6021.460.10	10.6021.460.11	10.6021.460.13/16/18

## Eindkap trapopgang met afdeklíjst links



| links te gebruiken  
| cut-to-size  
| VE: 1 stuks

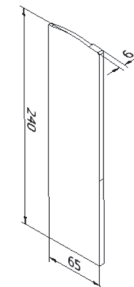

Model 6021	Onbehandeld	Aluminium naturel	In kleur
Toepassing	Art. nr.	Art. nr.	Art. nr.
links	10.6021.411.10	10.6021.411.11	10.6021.411.13/16/18

# TL-6021 | 1.0KN ZIJMONTAGE

## Eindkap trapopgang met afdeklíjst rechts



- | rechts te gebruiken
- | cut-to-size
- | VE: 1 stuks

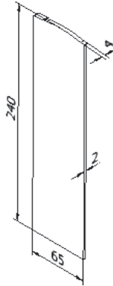

Model 6021	Onbehandeld	Aluminium naturel	In kleur
Toepassing	Art. nr.	Art. nr.	Art. nr.
rechts	10.6021.461.10	10.6021.461.11	10.6021.461.13/16/18

## Afdeklíjst



- | Met bevestigingsstrip
- | Voor het gebruik van een afdekkap moeten eindkappen worden mee besteld
- | VE: 1 stuks

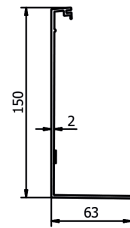

Model 6021	Onbehandeld	Aluminium naturel	In kleur
Lengte	Art. nr.	Art. nr.	Art. nr.
2500	-	10.6021.202.11	-
5000	10.6021.205.10	10.6021.205.11	10.6021.205.13/16/18

## Afstandhouder



- | Dicke: 15 mm
- | VE: 1 stuks

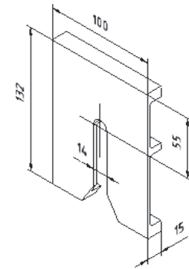

Model 6021	Onbehandeld	Aluminium naturel	In kleur
	Art. nr.	Art. nr.	Art. nr.
	10.6021.500.10	10.6021.500.11	10.6021.500.13/16/18

## Blinde plug



- | Benodigd aantal per 2500 mm: 17 stuks
- | VE: 10 stuks

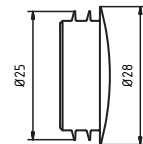

Model 7000	Kunststof	
Kleur	Diameter	Art. nr.
wit	30 mm	90.7000.030.40
zwart	30 mm	90.7000.030.41
grijs	30 mm	90.7000.030.45

# TL-6021 | 1.0KN ZIJMONTAGE

## Verlengstift



- | Lengte 40 mm
- | Diameter Ø 6 mm
- | VE: 8 stuks

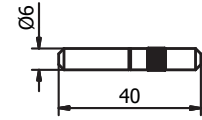

Model 7001	316 (binnen & buiten)
Art. nr.	
90.7001.640.31	

## Fischer bevestigingsanker FH II 12/10



- | Oppervlakte binnentoepassing: Staal verzinkt (binnen)
- | Oppervlakte buitentoepassing: 316 (buiten)
- | Benodigd aantal per 2500 mm: 13 stuks
- | VE: 50 stuks

**fischer** 

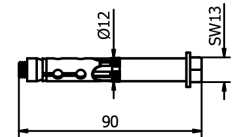

Model 3521	Staal verzinkt (binnen)	316 (buiten)
Art. nr.		Art. nr.
91.3521.210.81		91.3521.210.30

## Montageset op staal



- | Oppervlakte binnentoepassing: Staal verzinkt (binnen)
- | Oppervlakte buitentoepassing: 316 (buiten)
- | Benodigd aantal per 2500 mm: 13 stuks
- | M10 x 60 mm
- | VE: 13 stuks

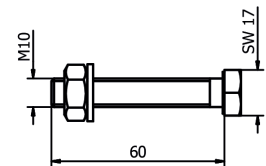

Model 6021	Staal verzinkt (binnen)	316 (buiten)
Art. nr.		Art. nr.
91.6021.060.81		91.6021.060.30

## Montageset op hout

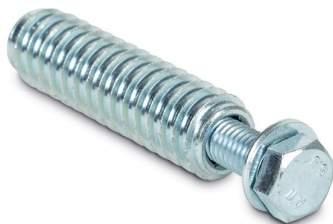

- | Oppervlakte binnentoepassing: Staal verzinkt (binnen)
- | Benodigd aantal per 2500 mm: 13 stuks
- | M12
- | VE: 13 stuks

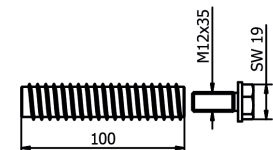

Model 6021	Staal verzinkt (binnen)
Art. nr.	
91.6021.800.81	



# TL-6021 | 1.0KN ZIJMONTAGE

## Schroefanker voor beton



- | Geschikt voor onze profielen zonder daling
- | Oppervlak binnentoepassing: Stahl verzinkt (binnen) HUS3-H 10x90
- | Oppervlak buitentoepassing: V4A (buiten) HUS3-HR 10x95
- | Tangentiële slagschroevendraaier noodzakelijk

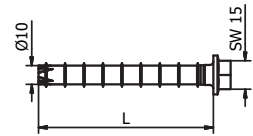

Model 3701	Staal verzinkt (binnen)	Model 3701	316 (buiten)
VE	Art. nr.	VE	Art. nr.
50	91.3701.090.81	25	91.3701.095.30

## FLEXFIT 1.0 kN



- | Fijnafstelling van glasplaten
- | Voor glasdiktes 12 - 21,52 mm
- | Uitlijning van max. 34 mm t.o.v. de loodlijn
- | Let op de juiste glasdikte!

Lengte		2500 mm	5000 mm	25 m
Glasdikte	Wig-kleur	Art. nr.	Art. nr.	Art. nr.
12 mm	zwart	90.0502.112.00	90.0505.112.00	90.0525.112.00
6/6/2 (12,76 mm)	rood	90.0502.113.00	90.0505.113.00	90.0525.113.00
6/6/4 (13,52 mm)	grijs	90.0502.114.00	90.0505.114.00	90.0525.114.00
15 mm	geel	90.0502.115.00	90.0505.115.00	90.0525.115.00
<b>8/8/2 (16,76 mm)</b>	rood	90.0502.117.00	90.0505.117.00	90.0525.117.00
<b>8/8/4 (17,52 mm)</b>	groen	90.0502.118.00	90.0505.118.00	90.0525.118.00
19 mm	blauw	90.0502.119.00	90.0505.119.00	90.0525.119.00
<b>10/10/2 (20,76 mm)</b>	rood	90.0502.121.00	90.0505.121.00	90.0525.121.00
<b>10/10/4 (21,52 mm)</b>	groen	90.0502.122.00	90.0505.122.00	90.0525.122.00