

Type Storax Dakluik 700 x 900 (70°)

Specificatie:

- 1 Thermisch onderbroken opstand met geïntegreerde waterslag in RAL 7047.
- 2 Deksel met thermische onderbreking. Buitenzijde RAL 7047.
- 3 Kunststof afdekplaat in RAL 9010.
- 4 PIR isolatie tegen de opstand RC 5,0 m² K/W.
- 5 PIR isolatie in het deksel RC 5,0 m² K/W.
- 6 Afdichtingsrubber D-profiel rondom.
- 7 RVS 316 scharnieren.
- 8 Gasveer met openstandvergrendeling.
- 9 Aluminium handrail met kunststof houders.
- 10 Europrofielcilinder: 55/55mm SKG**.
- 11 Zwart kunststof handgreep.

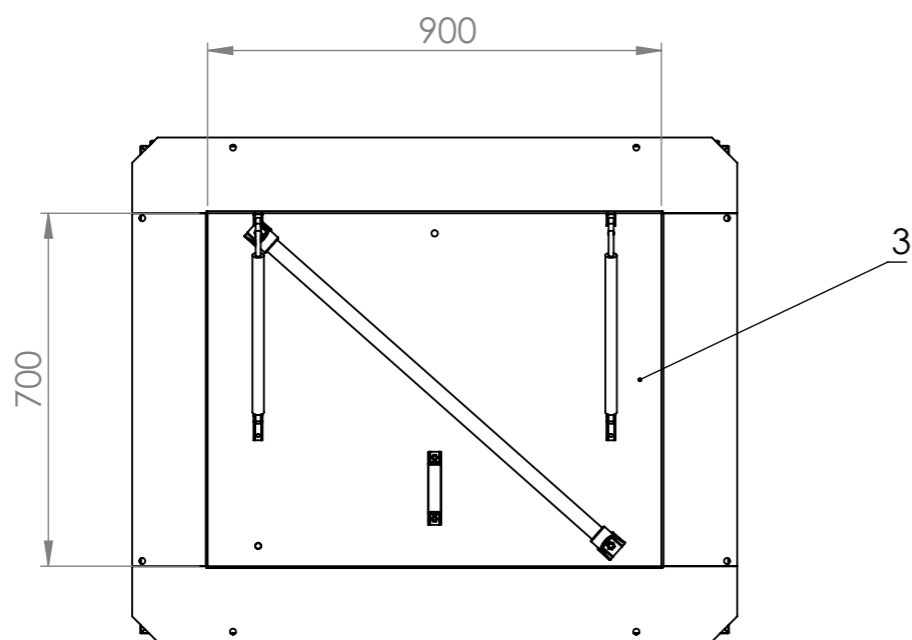
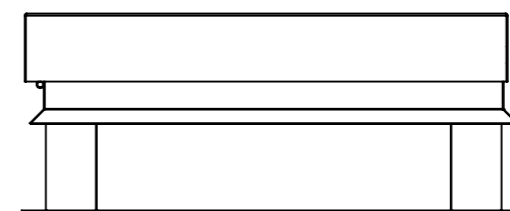
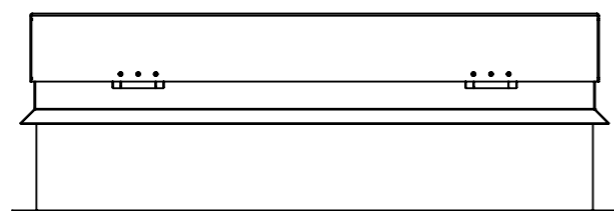
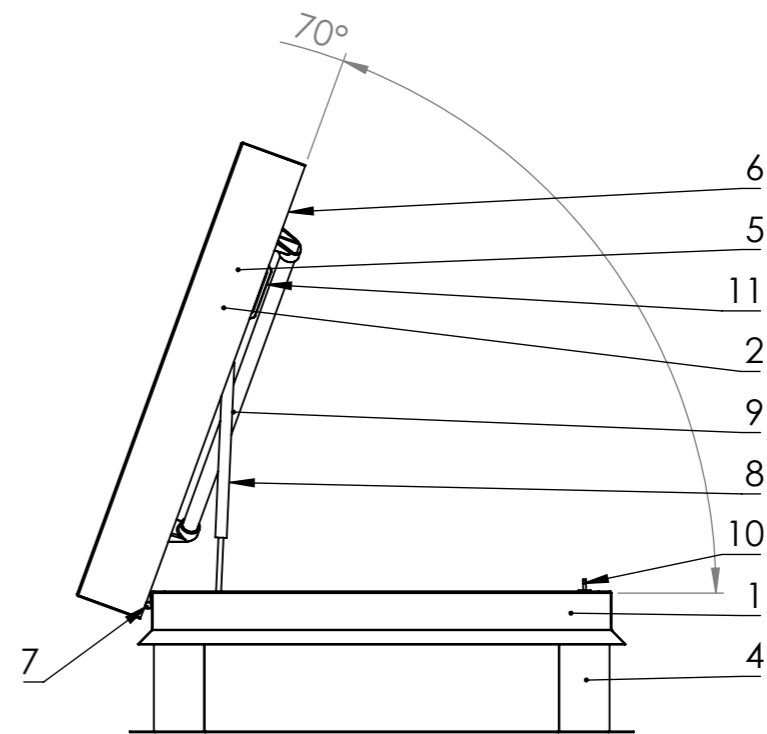

	Name		Date		Project: [SD] Storax	
	Drawn by				Title:	
	Appr. By				Dakluik samenstelling 700x900	
	Checked by					
UNLESS OTHERWISE SPECIFIED DIMENSIONS ARE IN MM						
angle		0.5 T/M 6	6 T/M 30	30 T/M 120	120 T/M 400	
±0.2		±0.1	±0.2	±0.3	±0.5	
PROPRIETARY AND CONFIDENTIAL THE INFORMATION CONTAINED IN THIS DRAWING IS THE SOLE PROPERTY OF MEMATEC GROEP. ANY REPRODUCTION IN PART OR AS A WHOLE WITHOUT THE WRITTEN PERMISSION OF MEMATEC GROEP IS PROHIBITED						
THIRD ANGLE PROJECTION			Sheet size: A3		Drawing nr. 000-00 Rev.	
			scale: 1:15		Material: Material <not specified>	
			thickness:		weight: 43474.48gr Sheet 3/3	