

Glasrailingbasis

Vloerprofielen voor topmontage

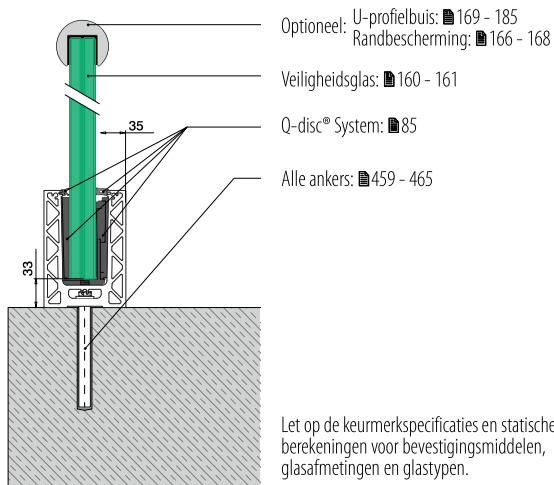

Optioneel: U-profielbuis: ■ 169 - 185
Randbescherming: ■ 166 - 168

Veiligheidsglas: ■ 160 - 161

Q-disc® System: ■ 85

Alle ankers: ■ 459 - 465

Let op de keurmerkspecificaties en statische berekeningen voor bevestigingsmiddelen, glasafmetingen en glastypen.

168610-025-00-00 18

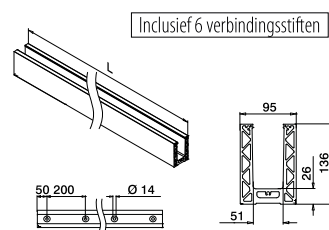
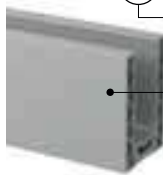

MOD 8610

Aluminium	Onbewerkt		
168610-025-00-00	■ 459 - 465		L = 2,5 m
Aluminium	Geborsteld, geanodiseerd		
OUTDOOR			
168610-025-00-18	■ 459 - 465		L = 2,5 m



Glasrailingbasis

Hoeken voor topmontage

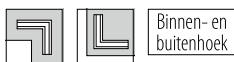

Binnen- en buitenhoek

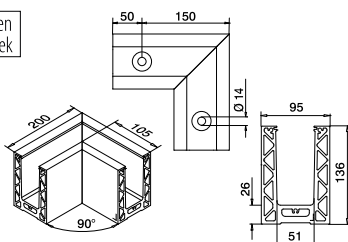

MOD 8611

Aluminium	Onbewerkt		
168611-00-00	■ 459 - 465		1
Aluminium	Geborsteld, geanodiseerd		
OUTDOOR			
168611-00-18	■ 459 - 465		1



International Design Model Protection

Q-INFO MOD 8610

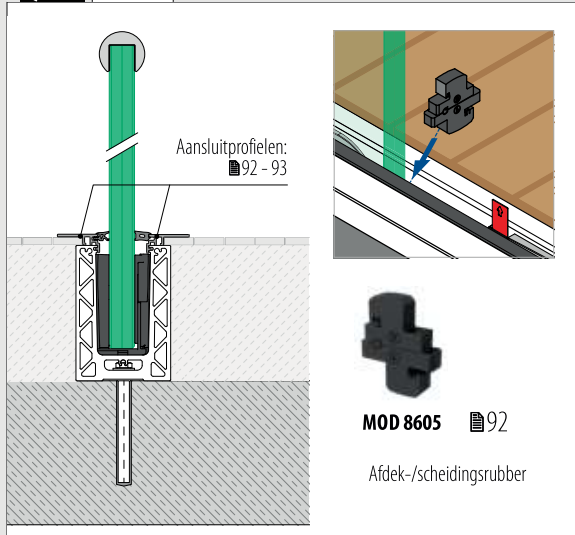

Q-INFO MOD 8610

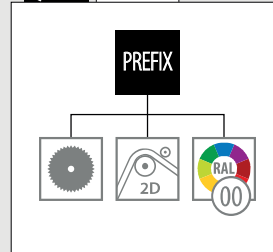

Q-INFO Aluminium

00	18
Onbewerkt	Geborsteld, geanodiseerd

Q-INFO

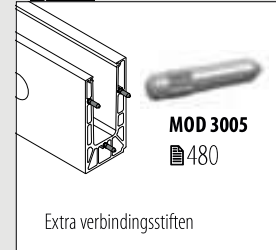

Eindkappen voor topmontage



MOD 8612

Aluminium

Onbewerkt

Tape

168612-00-00	Los bijgeleverd	1
--------------	-----------------	---

Aluminium

Geborsteld, geanodiseerd

OUTDOOR

168612-00-18	Voorgemonteerd	1
--------------	----------------	---

NEW

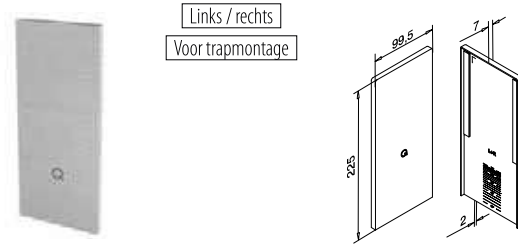

MOD 8613

Aluminium

Onbewerkt

Tape

168613-00-00	Los bijgeleverd	1
--------------	-----------------	---

Aluminium

Geborsteld, geanodiseerd

OUTDOOR

168613-00-18	Voorgemonteerd	1
--------------	----------------	---

NEW

Opvulplaten voor topmontage

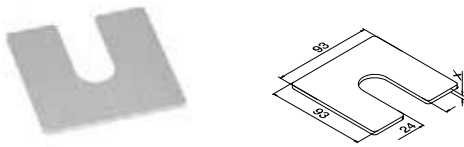

MOD 8616

Aluminium

Onbewerkt

X

168616-001	1	100
------------	---	-----

168616-002	2	100
------------	---	-----

168616-003	3	100
------------	---	-----

NEW

Drainageprofielen voor topmontage

4 stuks voor 2,5 meter vloerprofiel

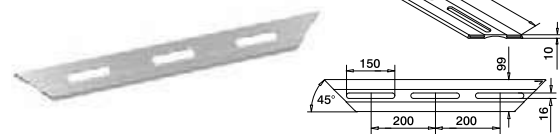

MOD 8617

Aluminium

Geborsteld, geanodiseerd

OUTDOOR

168617-18	4
-----------	---

NEW

Q-INFO MOD 8612

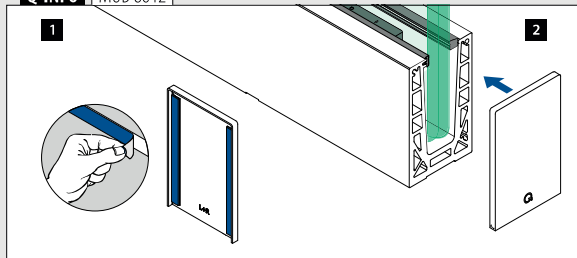

Q-INFO MOD 8616

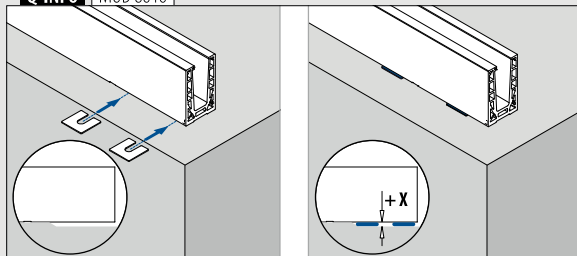

Q-INFO MOD 8613

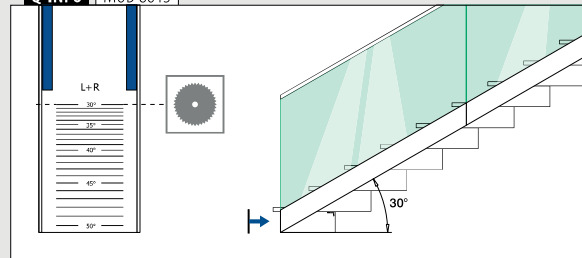

Q-INFO MOD 8617

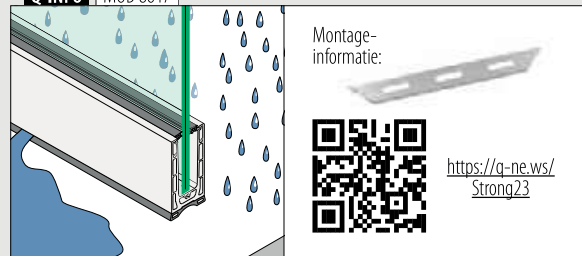

Montage-informatie:



<https://q-ne.ws/Strong23>